



TKS

興勤電子工業股份有限公司

2020年Q1法人說明會

免責聲明

本報告內容係依現有資訊而做成，上述說明中的財務或相關資訊可能包含一些對本公司及其子公司未來前景的說明，這些說明易受重大的風險和不確定性因素影響，致使最後結果與原先的說明迥異，是本公司特此聲明，本報告中的內容，僅為資訊流通之目的而公佈，並非投資建議，本公司不對報告內容的正確性、完整性或任何使用本報告內容所產生的損害負任何責任





公司介紹



競爭優勢



主要市場



營運概況



- 創立於1979年的保護元件廠家
- 擁有7間工廠和3800名員工
- 2019年營收:58.14億台幣

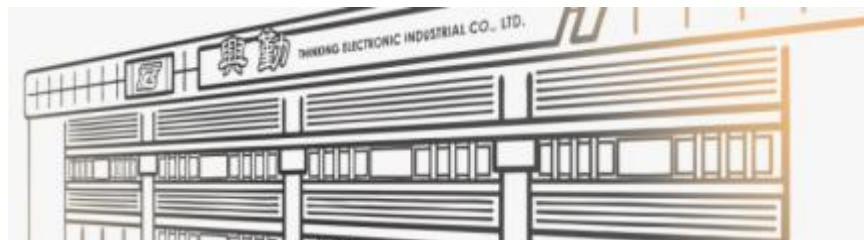

● 生產基地

台灣



高雄二廠



高雄一廠



宜蘭廠

華東



常州廠



景德鎮廠

華南



東莞廠

華中



宜昌廠

過電壓防護



General Protection



ESD Protection



Spark Gap Protector



Primary Protection



TVS Diode

過電流保護



NTC ICL



Ceramic PTC Thermistor

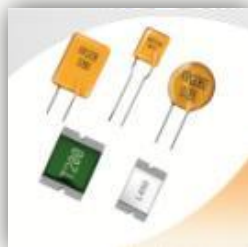

Polymer PTC Thermistor

過溫度偵測與防護



NTC Thermistor



Ceramic PTC Thermistor



Temperature Sensor







公司介紹



競爭優勢



主要市場



營運概況



主要市場

資訊
與
通訊

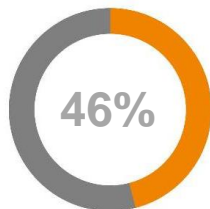

電源



電腦



消費電子



通訊

家電
與
照明

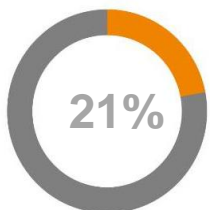

家電



照明

汽車
與
工業

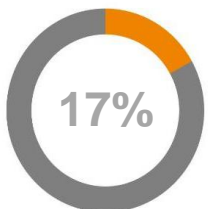

工業



汽車

醫療
與
其它

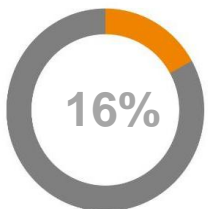

醫療

Other

其它應用



經銷商





公司介紹



競爭優勢



主要市場



營運概況



- 從原料至產品生產均由興勤掌握，確保產品品質

材料開發技術	前製程技術	產品設計技術	後製程技術
			
<ul style="list-style-type: none"> ● 材料設計 ● 材料生產 	<ul style="list-style-type: none"> ● 堆疊技術 ● 塗裝技術 ● 燒結技術 ● 表面處理 	<ul style="list-style-type: none"> ● SMD產品設計 ● 插件型產品設計 ● 傳感器組裝 	<ul style="list-style-type: none"> ● 包封組裝 ● 量測與檢驗 ● 自動化



- 設有UL和TUV認可的實驗室，提供電路保護元件的驗證服務。



- 獲得政府頒發「工程技術研究中心」以及「高新技術企業」認證。



- 除了政府的肯定，專利數也顯現與勤的研發成果，與勤獲准的專利件數逐年增加。

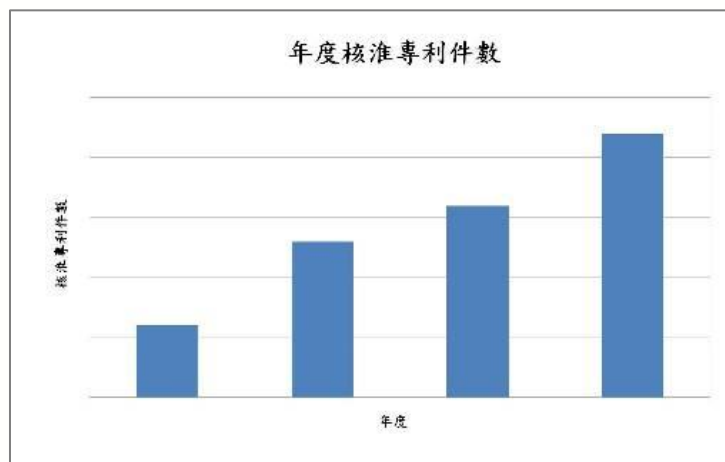

興勤AE團隊 提供完整的技術支援

技術諮詢

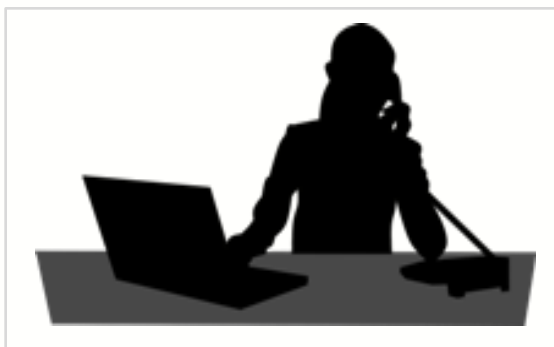

電路設計協助

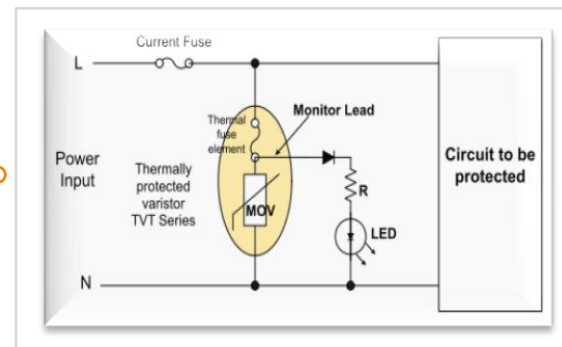

產品選型建議



產品測試服務

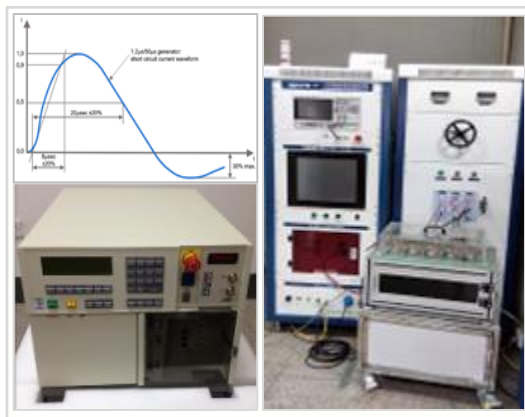

應用案例

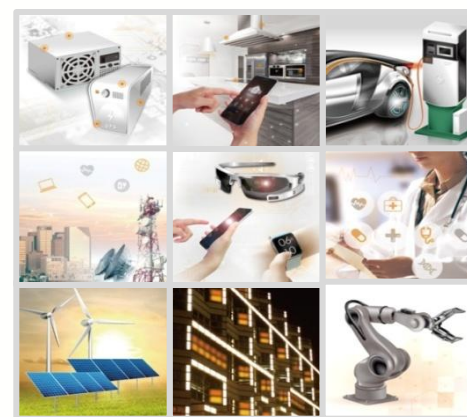



公司介紹



競爭優勢



主要市場



營運概況



營運概況：合併損益表

單位：新台幣千元

損益項目	2019Q1	2019Q4	2020Q1	QoQ	YoY
營業收入淨額	1,404,060	1,522,209	1,095,742	-28.0%	-22.0%
營業毛利	549,327	635,191	424,421	-33.2%	-22.7%
毛利率	39.1%	41.7%	38.7%	-3.0%	-0.4%
營業費用	208,962	238,442	182,607	-23.4%	-12.6%
營業利益	340,365	396,749	241,814	-39.1%	-29.0%
營業利益率	24.2%	26.1%	22.1%	-4.0%	-2.2%
業外收支	-1,820	-9,616	25,921	-369.6%	-1524.2%
稅後淨利	253,454	286,288	196,819	-31.3%	-22.3%
每股盈餘(元)	1.95	2.25	1.56	-0.69	-0.39

營運概況：合併資產負債表

單位：新台幣千元

項目	2019.3.31	2019.12.31	2020.3.31	%	QoQ	YoY
現金及銀行存款	1,887,674	1,774,594	1,903,159	21%	7.2%	0.8%
應收帳款	1,969,186	2,046,553	1,728,076	19%	-15.6%	-12.2%
存貨	933,911	822,298	811,597	9%	-1.3%	-13.1%
流動資產	5,941,783	6,067,809	6,196,992	70%	2.1%	4.3%
固定資產	2,134,590	2,090,206	2,092,029	24%	0.1%	-2.0%
非流動資產	2,690,839	2,682,706	2,691,138	30%	0.3%	0.0%
資產總額	8,632,622	8,750,515	8,888,130	100%	1.6%	3.0%
應付帳款	637,352	533,753	466,938	5%	-12.5%	-26.7%
其他應付款	391,940	427,390	355,587	4%	-16.8%	-9.3%
流動負債	1,313,230	1,254,736	1,171,906	13%	-6.6%	-10.8%
非流動負債	920,635	980,796	1,022,499	12%	4.3%	11.1%
負債總額	2,233,865	2,235,532	2,194,405	25%	-1.8%	-1.8%
權益總額	6,398,757	6,514,983	6,693,725	75%	2.7%	4.6%

營運概況：財務比率分析

項目		2019. 3. 31	2019. 12. 31	2020. 3. 31	QoQ	YoY
負債比率		25.87%	25.54%	24.68%	-0.86%	-1.19%
流動比率		452.45%	483.59%	528.79%	45.20%	76.34%
應收 帳款	周轉率(次)	2.77	2.82	2.32	-0.50	-0.45
	平均收現日數	131.76	129.43	157.32	27.89	25.56
存貨	周轉率(次)	3.60	3.89	3.28	-0.61	-0.32
	平均銷貨日數	101.38	93.83	111.28	17.45	9.90
應付 帳款	周轉率(次)	5.37	5.94	5.36	-0.58	-0.01
	平均付款日數	67.97	61.45	68.10	6.65	0.13



營運概況:近年營收及每股盈餘

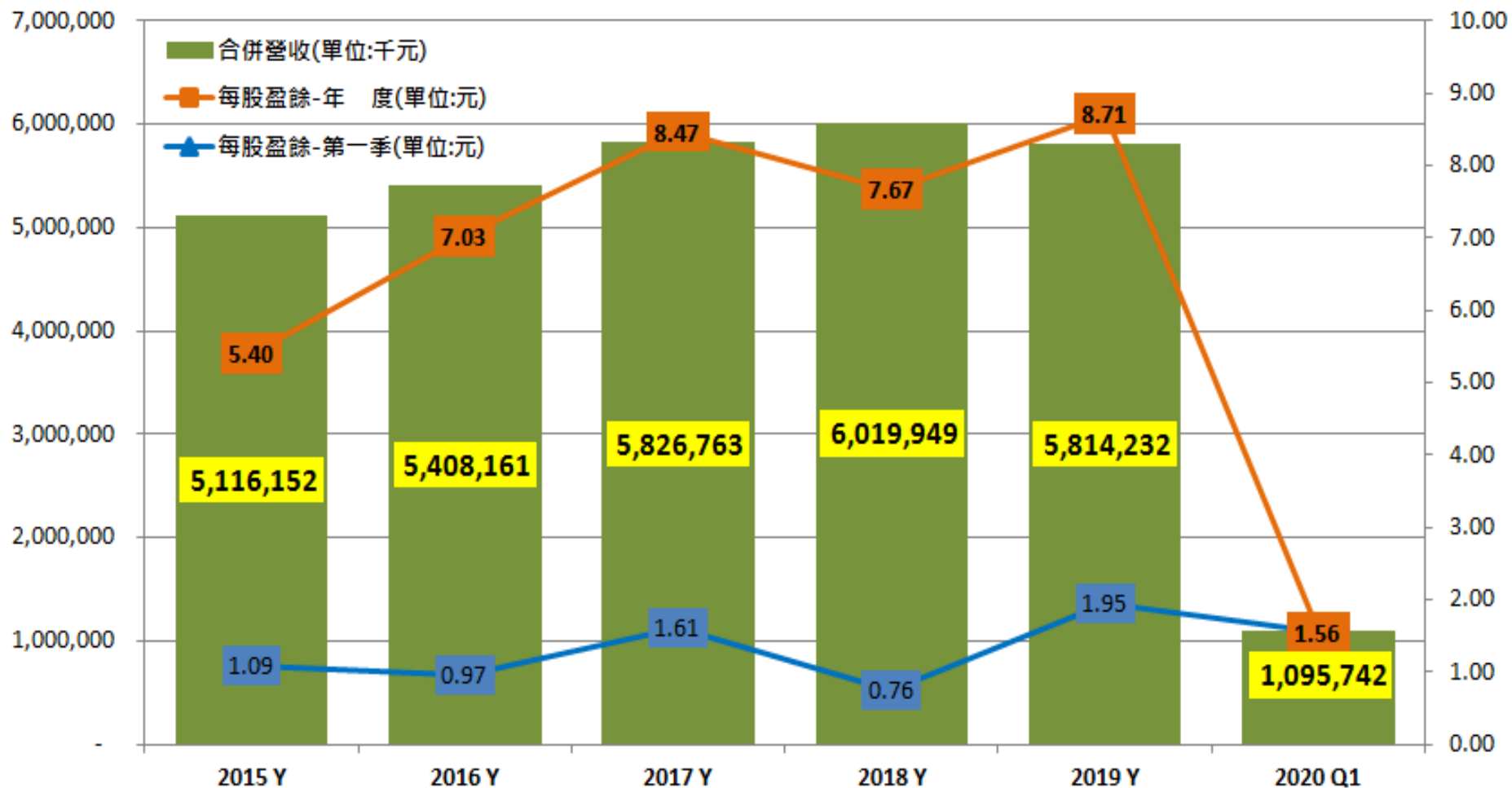



Q&A

謝謝您！



感謝聆聽

台灣高雄市左營區大順一路93號12樓

電話:(07)5577660

傳真:(07)5570560

Email:thinking@thinking.com.tw

官網:www.thinking.com.tw

